

JOINT INSTITUTE FOR NUCLEAR RESEARCH
Dzhelepov Laboratory of Nuclear Problems

FINAL REPORT ON THE SUMMER STUDENT PROGRAMME

**Measurement of the efficiency of B-physics trigger in
the ATLAS experiment**

Supervisor:

Dr. Semen Turchikhin

Student:

Marina Aleksandrova, Russia
Lomonosov Moscow State University,
Faculty of Physics

Participation period:

July 07 – August 17

Dubna, 2019

1 Introduction

ATLAS is one of the four main detectors at the Large Hadron Collider (LHC) at CERN intended to investigate the elementary particle physics [1]. The trigger system is an essential component of any collider experiment that is responsible for deciding whether or not to keep an event from a given bunch-crossing interaction for later study. Measurement of the efficiency of B-physics triggers is necessary for many analyses, such as b hadron production cross-section measurements, studies of various b decay parameters, and searches for rare and forbidden decays, such as $\tau^+ \rightarrow \mu^+ \mu^- \mu^+$.

2 ATLAS detector and trigger system

ATLAS is a general-purpose detector at the LHC. It has a cylindrical geometry which covers almost the entire solid angle around the proton-proton interaction point. The main components of ATLAS are Inner Detector (ID), calorimeter system, and Muon Spectrometer (MS). The ID provides track reconstruction within pseudorapidity range $|\eta| < 2.5$. It is surrounded by a superconducting solenoid creating a 2 T axial magnetic field. The calorimeters cover the region $|\eta| < 4.9$ and consist of electromagnetic and hadronic sections. The MS includes one barrel ($|\eta| < 1.05$) and two end-caps ($1.05 < |\eta| < 2.7$). It is mounted in an air-core toroidal magnet system. Precision tracking measurements in the bending plane are provided by Monitored Drift Tubes (MDT) over the region $|\eta| < 2.7$ and by Cathode Strip Chambers (CSC) in the region $2 < |\eta| < 2.7$. Resistive Plate Chambers (RPC) and Thin Gap Chambers (TGC) with a fast response time are used to trigger muons in the rapidity ranges $|\eta| < 1.05$ and $1.05 < |\eta| < 2.4$, respectively. Momentum measurements in the MS are based on track segments formed separately in at least two of the three station layers of the MDT and the CSC. The RPC and TGC are used to improve the pattern recognition and track reconstruction in the non-bending plane.

The Trigger and Data Acquisition (TDAQ) system is shown in Figure 1 [2]. It consists of a hardware-based first-level trigger (L1) and a software-based high-level trigger (HLT). The L1 trigger decision is formed by the Central Trigger Processor (CTP) based on information received from the L1 calorimeter (L1Calo) and L1 muon (L1Muon) triggers. The CTP is also responsible for applying preventive dead-time. It limits the minimum time between two consecutive L1 accepts (simple dead-time) to avoid overlapping read-out windows. It also restricts the number of L1 accepts allowed in a given number of bunch-crossings (complex dead-time) to avoid front-end buffers from overflowing. In 2015 running, the simple dead-time was set to 4 bunch-crossings (100 ns). After the L1 trigger acceptance, the events are buffered in the Read-Out System (ROS) and processed by the HLT. The HLT receives Region-of-Interest (RoI) information from L1, which can be used for regional reconstruction of events. After the events are accepted by the HLT, they are transferred to local storage at the experimental site and exported to the Tier-0 facility at CERN's computing centre for offline reconstruction.

The trigger selection of events for B-physics analyses is primarily based on the identification of b-hadrons through decays including a muon pair in the final state. Examples are decays with charmonium, $B \rightarrow J/\psi(\rightarrow \mu^+ \mu^-)X$, rare decays $B_{(s)}^0 \rightarrow \mu^+ \mu^-$, bottomonia decays $\Upsilon(1, 2, 3S) \rightarrow \mu^+ \mu^-$ and semileptonic decay $B \rightarrow \mu^+ \mu^- X$. Triggers for B-physics analyses (primary triggers) require two muons at L1. At the HLT, muons are reconstructed with requirement that two muons should have opposite charges and form a good

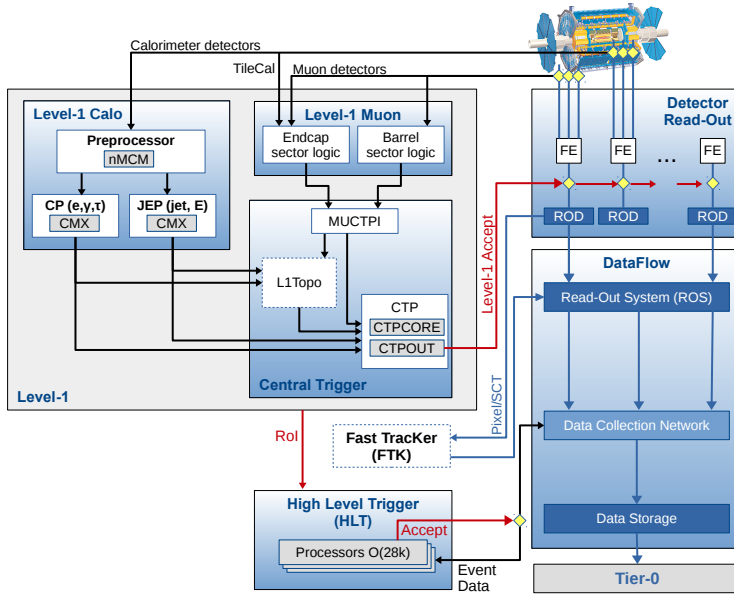

Figure 1: The ATLAS TDAQ system in Run 2.

vertex within a certain invariant mass window. The primary triggers use three dimuon mass windows: 2.5 to 4.3 GeV intended for selection of J/ψ and $\psi(2S)$ decays into muon pairs, 4.0 to 8.5 GeV for $B_{(s)}^0 \rightarrow \mu^+\mu^-$ decays, and 8 to 12 GeV for $\Upsilon(1, 2, 3S) \rightarrow \mu^+\mu^-$ decays. These invariant mass selections are indicated by the `bJpsimumu`, `bMmumu` and `bUpsimumu` suffixes in the trigger names, respectively.

3 Di-muon trigger efficiency

B-physics programme in ATLAS includes measurements of CP violating effects in B meson decays, searches for rare b decays, studies of the production cross sections, spectroscopy of b hadrons. The measurement of the HLT trigger efficiency is primarily required to calculate the b hadron production cross-section and useful for certain other studies.

The efficiency of the di-muon trigger to select events that have passed the offline selection criteria, ϵ_{trig} , can be factorized into three terms [3]:

$$\epsilon_{\text{trig}} = \epsilon_{\text{RoI}}(p_{T1}^\mu, q_1 \cdot \eta_1^\mu) \times \epsilon_{\text{RoI}}(p_{T2}^\mu, q_2 \cdot \eta_2^\mu) \times c_{\mu\mu}(\Delta R, |y^{\mu\mu}|)$$

where ϵ_{RoI} is the efficiency of the trigger system to find an RoI for a single muon with transverse momentum, p_T^μ , and charge-signed pseudorapidity, $q \cdot |\eta^\mu|$, and $c_{\mu\mu}$ is a correction for effects related to the dimuon elements of the trigger. The dimuon correction, $c_{\mu\mu}$, consists of two components:

$$c_{\mu\mu}(\Delta R, |y^{\mu\mu}|) = c_a(|y^{\mu\mu}|) \times c_{\Delta R}(\Delta R, |\eta^{\mu\mu}|)$$

The difference between $|y^{\mu\mu}|$ and $|\eta^{\mu\mu}|$ is negligible because dimuons are ultrarelativistic. The asymptotic correction, c_a , accounts for the effect of the efficiency losses due to dimuon vertex fit and opposite charge requirements at large dimuon angular separation. The ΔR correction, $c_{\Delta R}$, includes the efficiency losses in the dimuon trigger if two muons are close enough together, so that only a single RoI is built by L1 trigger. Data collected by ATLAS in pp collisions in 2015 and corresponding Monte Carlo (MC) samples are used in the current trigger efficiency measurements.

3.1 Asymptotic dimuon correction

The asymptotic correction, c_a , is evaluated in three separate regions of dimuon rapidity: barrel ($|y^{\mu\mu}| \leq 1.0$), overlap ($1.0 < |y^{\mu\mu}| \leq 1.2$), and endcap ($1.2 < |y^{\mu\mu}| \leq 2.3$). The correction c_a is found using the ratio of $J/\psi(\rightarrow \mu^+\mu^-)$ decay yields selected by two types of dimuon triggers. The first type of triggers requires that the events contain two opposite-sign muons and form a good common vertex. These triggers are: HLT_2mu4_bJpsimumu, HLT_mu6_mu4_bJpsimumu, HLT_2mu6_bJpsimumu, HLT_2mu4_bDimu, HLT_2mu4_bJpsimumu_noL2, HLT_2mu4_bDimu_noEFbph. Numbers in the trigger names denote p_T threshold value of muons in GeV and suffixes indicate invariant mass restriction. The second type of triggers makes no charge and vertex requirements and includes HLT_2mu4_bDimu_novtx_noos, HLT_mu6_mu4_bDimu_novtx_noos, HLT_2mu6_bDimu_novtx_noos. Dimuon candidates with invariant mass, $m_{\mu\mu}$, in a range 2.7–3.5 GeV are considered. The correction c_a is calculated according to the following equation:

$$c_a(|y^{\mu\mu}|) = \frac{N_{J/\psi}(\text{HLT_2muX})}{N_{J/\psi}(\text{HLT_2muX_novtx_noos})},$$

$$c_a(|y^{\mu\mu}|) = \frac{N_{J/\psi}(\text{HLT_muX_muY})}{N_{J/\psi}(\text{HLT_muX_muY_novtx_noos})}$$

The yields $N_{J/\psi}$ are extracted by an unbinned maximum likelihood fit to the dimuon invariant mass distribution. Values of c_a for data 2015 and MC as a function of ΔR in three rapidity regions are shown in Figures 2 and 3, respectively. The asymptotic correction does not depend on cuts on $m_{\mu\mu}$. Mass window for trigger HLT_2mu4_bJpsimumu is 2.5–4.3 GeV while trigger HLT_2mu4_bDimu_noEFbph has wider mass window 1.5–14 GeV. No difference in behavior of the correction for these two triggers is observed. The dominant part of the trigger efficiency loss related to vertex fit and opposite charge requirements comes from dimuon selection by fast L2 B-physics algorithm. This algorithm is not applied for HLT_2mu4_bJpsimumu_noL2 trigger, so larger values of c_a can be seen. The reason of the drop of c_a at large ΔR in MC samples is under investigation. Results for the asymptotic correction are similar for triggers with different dimuon momentum thresholds. Fits for the correction for HLT_2mu4_bJpsimumu trigger are shown in Figure 4.

Values of the asymptotic correction as a function of the dimuon transverse momentum, $p_T(\mu\mu)$, (Figure 5) agree with its ΔR distribution. The drop of c_a at large ΔR and at small $p_T(\mu\mu)$ is observed in MC samples.

3.2 ΔR correction and total dimuon correction

The correction $c_{\Delta R}$ accounts for dependence of the dimuon trigger efficiency on the distance between two muon RoIs, which may overlap thus preventing the L1 trigger from resolving them apart. The correction is derived as a function of ΔR in three regions of

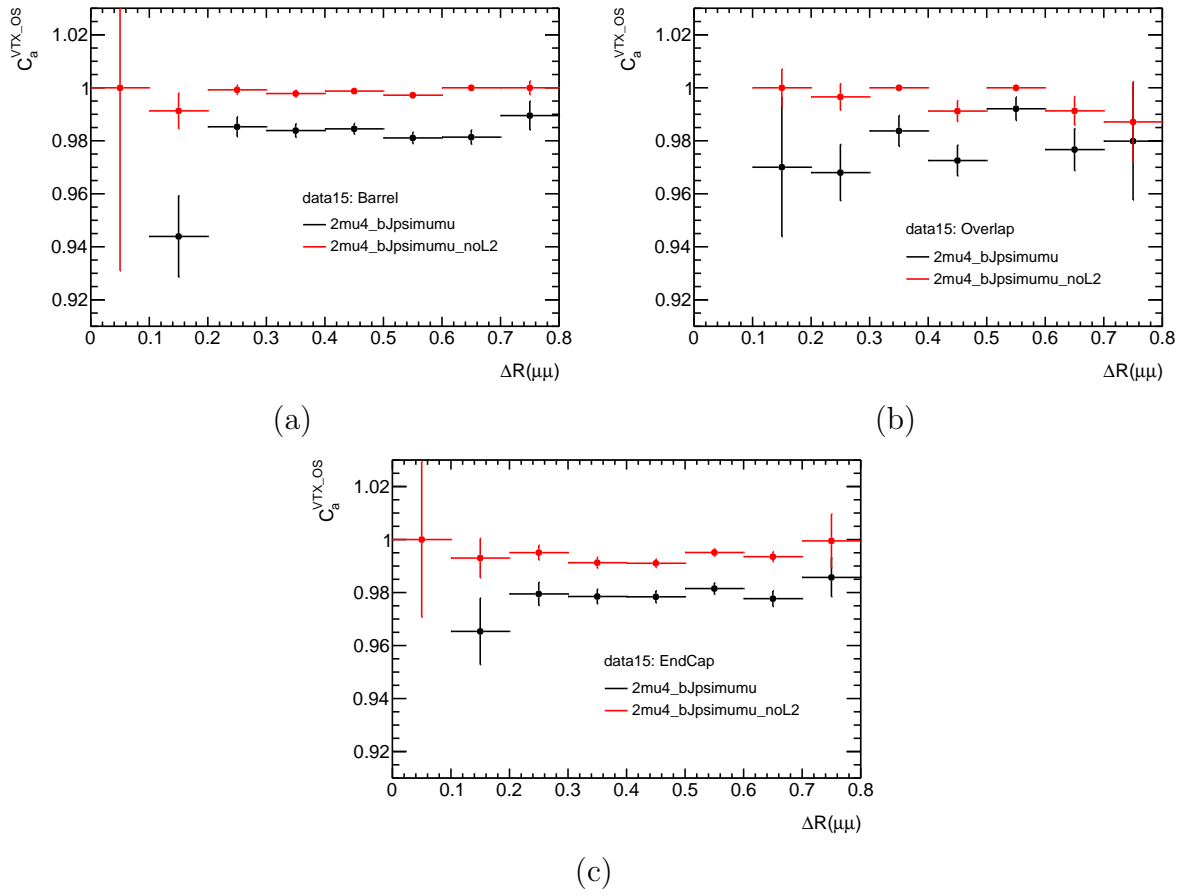

Figure 2: The asymptotic correction, c_a , for data 2015 as a function of ΔR in (a) Barrel, (b) Overlap, and (c) EndCap regions.

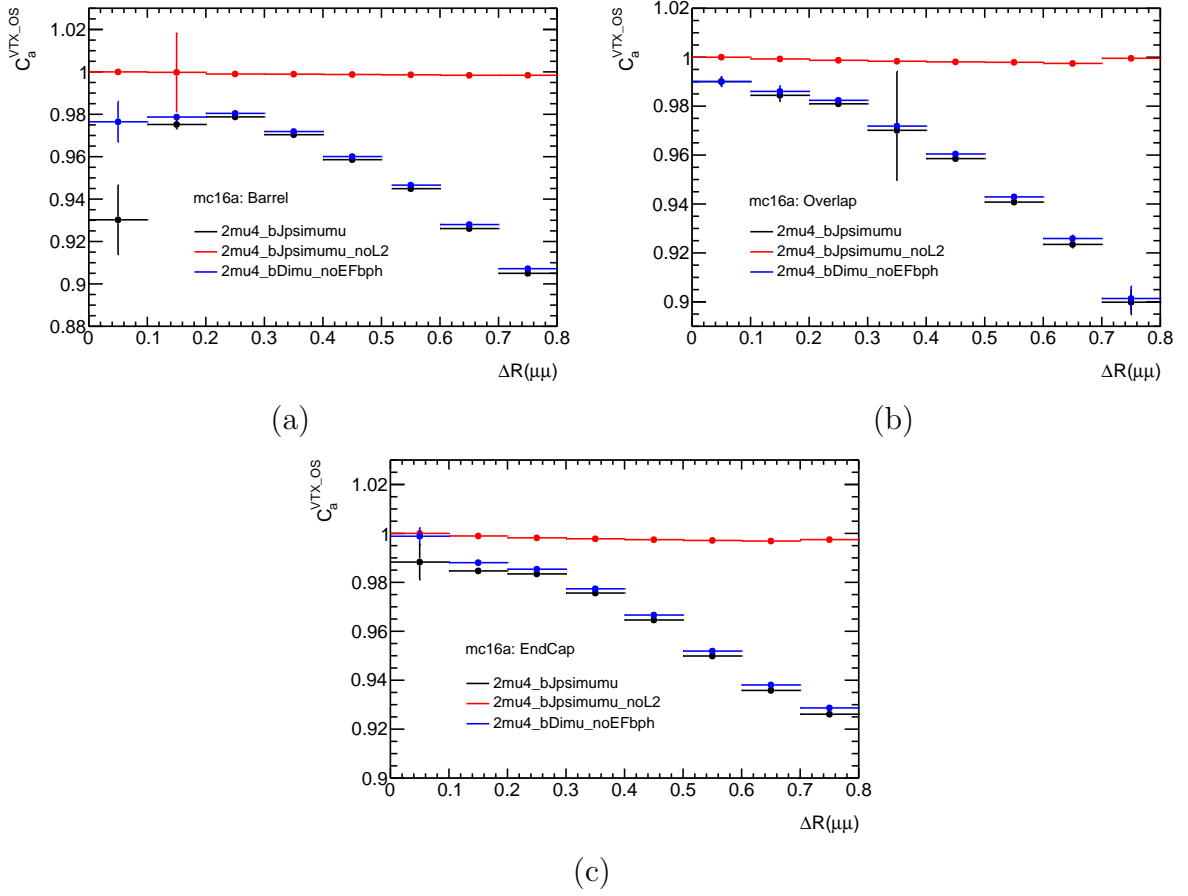

Figure 3: The asymptotic correction, c_a , for MC as a function of ΔR in (a) Barrel, (b) Overlap, and (c) EndCap regions.

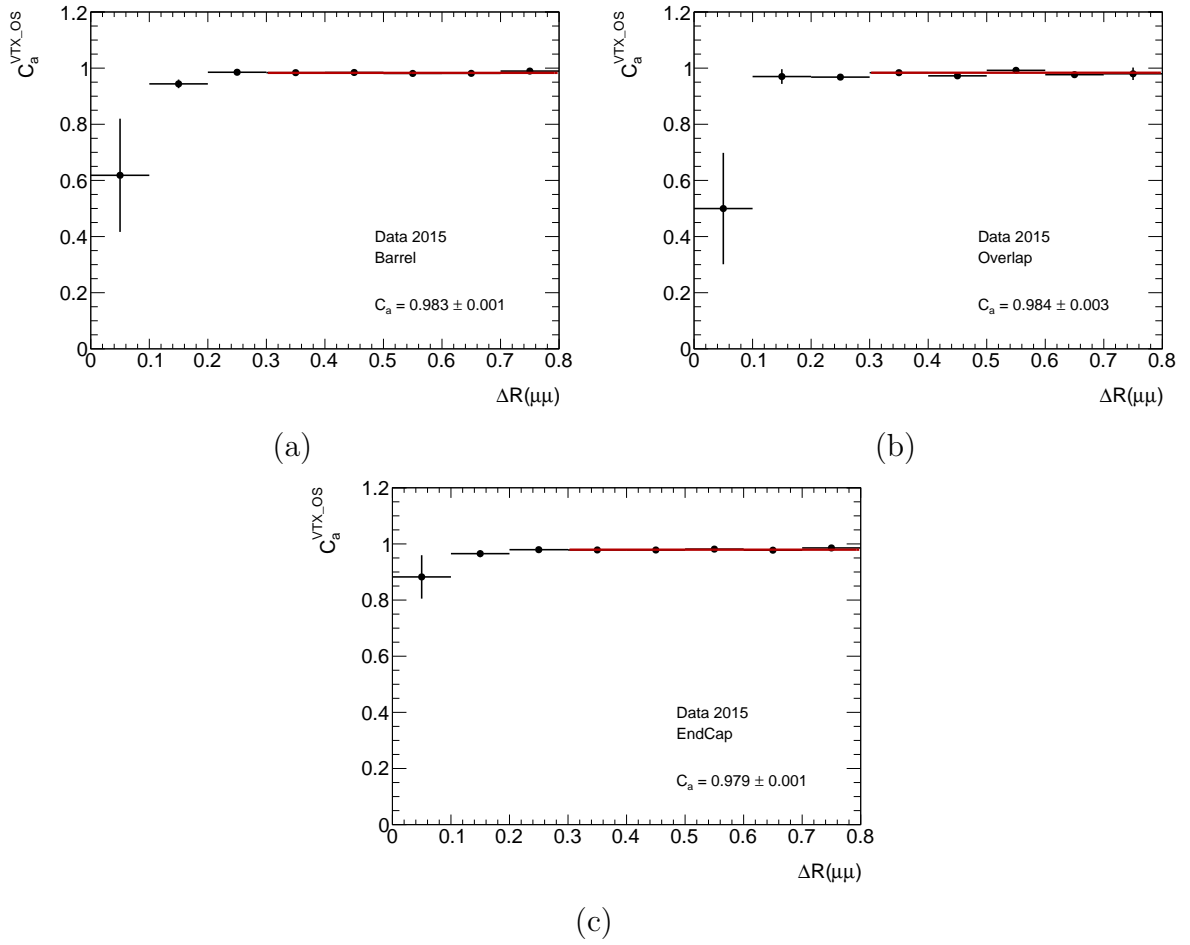

Figure 4: Fits for c_a as a function of ΔR for HLT_2mu4_bJpsimumu trigger in (a) Barrel, (b) Overlap, and (c) EndCap regions.

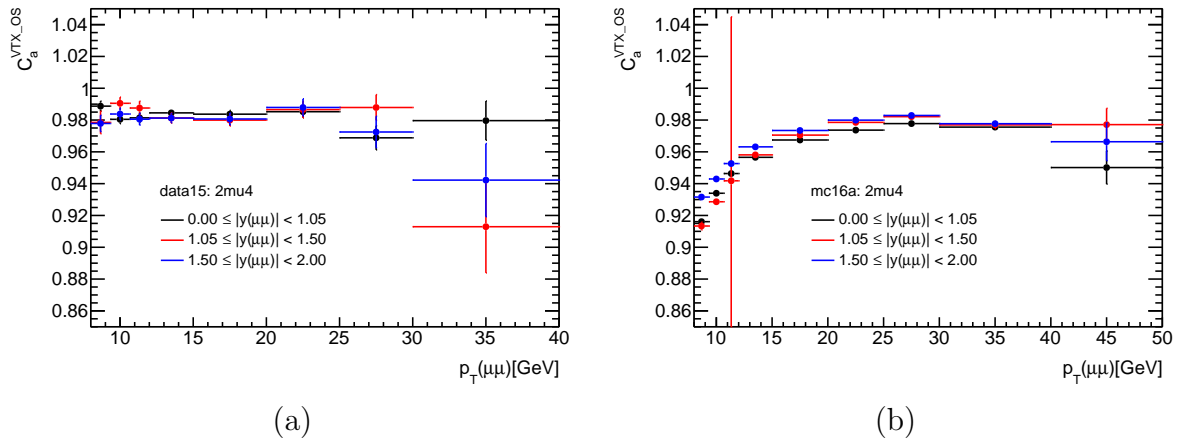

Figure 5: The asymptotic correction, c_a , for HLT_2mu4_bJpsimumu trigger as a function of p_T for (a) data 2015 and (b) MC.

dimuon pseudorapidity: barrel ($|\eta^{\mu\mu}| \leq 1.0$), overlap ($1.0 < |\eta^{\mu\mu}| \leq 1.2$), and endcap ($1.2 < |\eta^{\mu\mu}| \leq 2.3$). Muons with $p_T > 8$ GeV are selected.

The following fraction is calculated:

$$\rho_{\Delta R}(\Delta R, |\eta^{\mu\mu}|) = \frac{N_{\Delta R}(\text{EF_muX} \cdot \text{HLT_2mu4_bJpsimumu})}{N_{\Delta R}(\text{EF_muX})}$$

where $N_{\Delta R}(\text{EF_muX})$ is the number of J/ψ which fire at least one of single muon triggers HLT_mu4_bJpsi_Trkloose, HLT_mu6_bJpsi_Trkloose, HLT_mu10_bJpsi_Trkloose, or HLT_mu18_bJpsi_Trkloose. The numerator $N_{\Delta R}(\text{EF_muX} \cdot \text{HLT_2mu4_bJpsimumu})$ denotes the number of J/ψ which fire both single and dimuon triggers. The distribution of $\rho_{\Delta R}$ (Figure 6) is well described by an error function. In order to evaluate $c_{\Delta R}$ correction the ratio $\rho_{\Delta R}$ is normalized to unity at the plateau. The value of $\rho_{\Delta R}$ at the plateau contains contributions from vertex fit and opposite charge requirements included in c_a correction and from losses of the single muon efficiencies. The $c_{\Delta R}$ correction is shown in Figure 7. The total dimuon correction of the efficiency, $c_{\mu\mu}$, is defined as the product of c_a and $c_{\Delta R}$ and is shown in Figure 8.

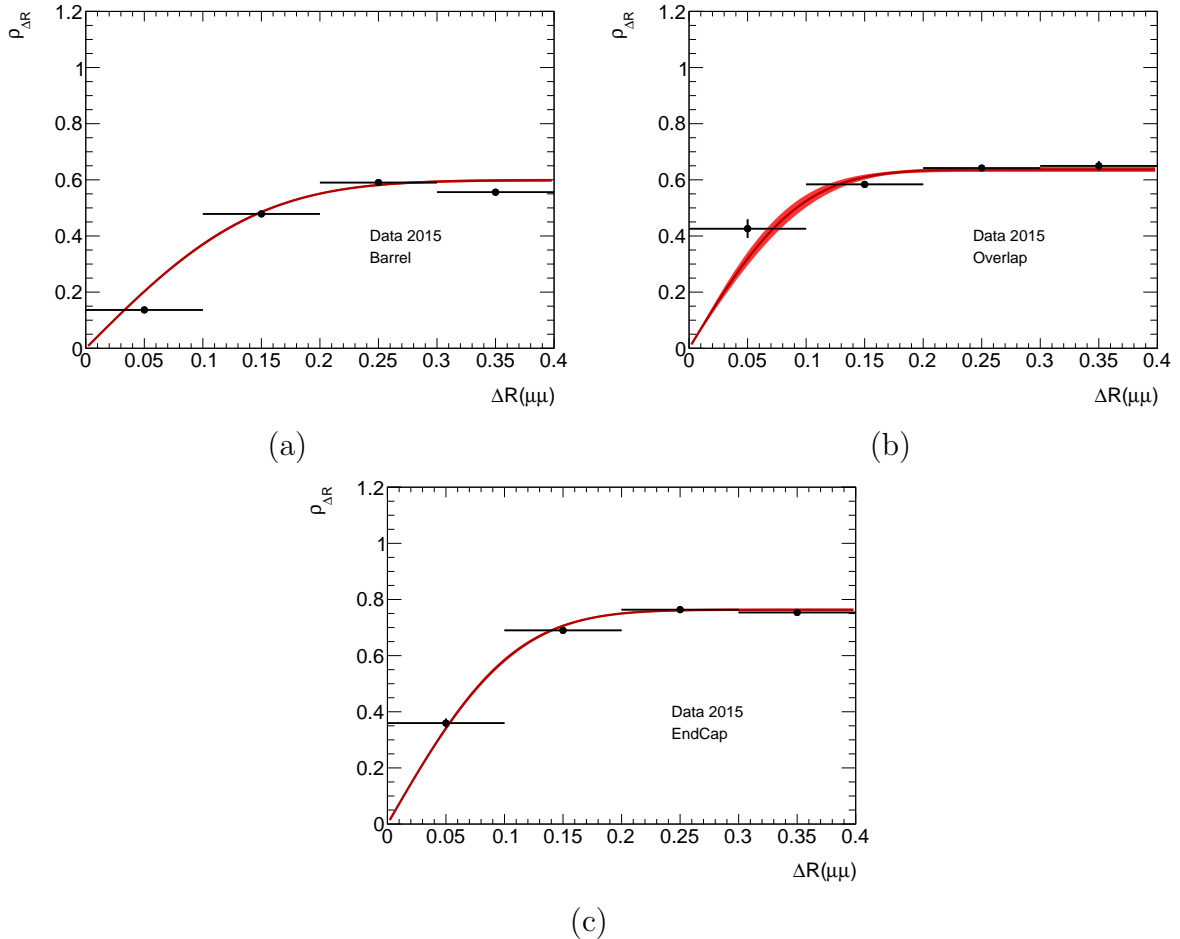

Figure 6: The ratio $\rho_{\Delta R}$ for HLT_2mu4_bJpsimumu trigger for data 2015 as a function of ΔR in (a) Barrel, (b) Overlap, and (c) EndCap regions. The uncertainty contour on $\rho_{\Delta R}$ is $\pm 1\sigma$.

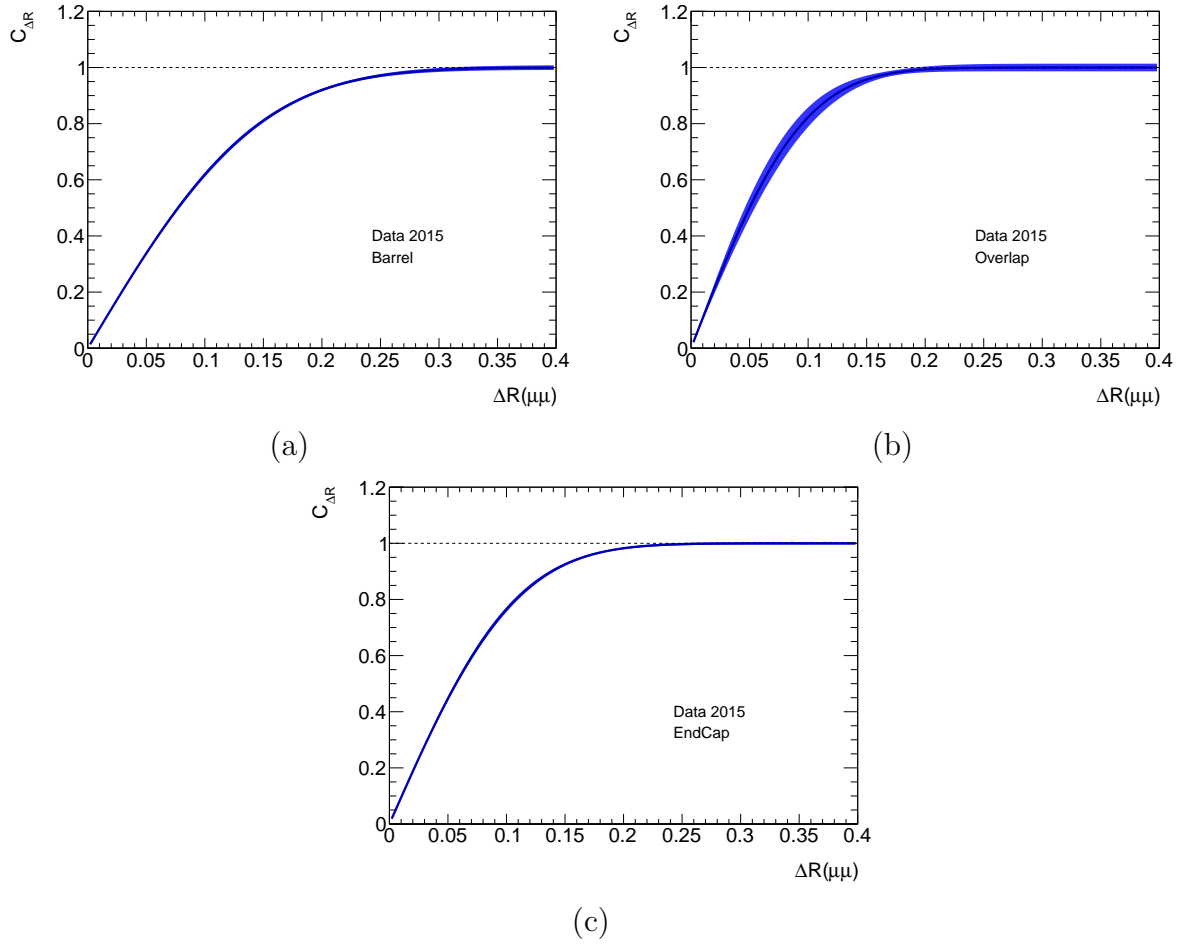

Figure 7: The $c_{\Delta R}$ correction for HLT_2mu4_bJpsimumu trigger as a function of ΔR for data 2015 in (a) Barrel, (b) Overlap, and (c) EndCap regions. The uncertainty contour on the correction is $\pm 1\sigma$.

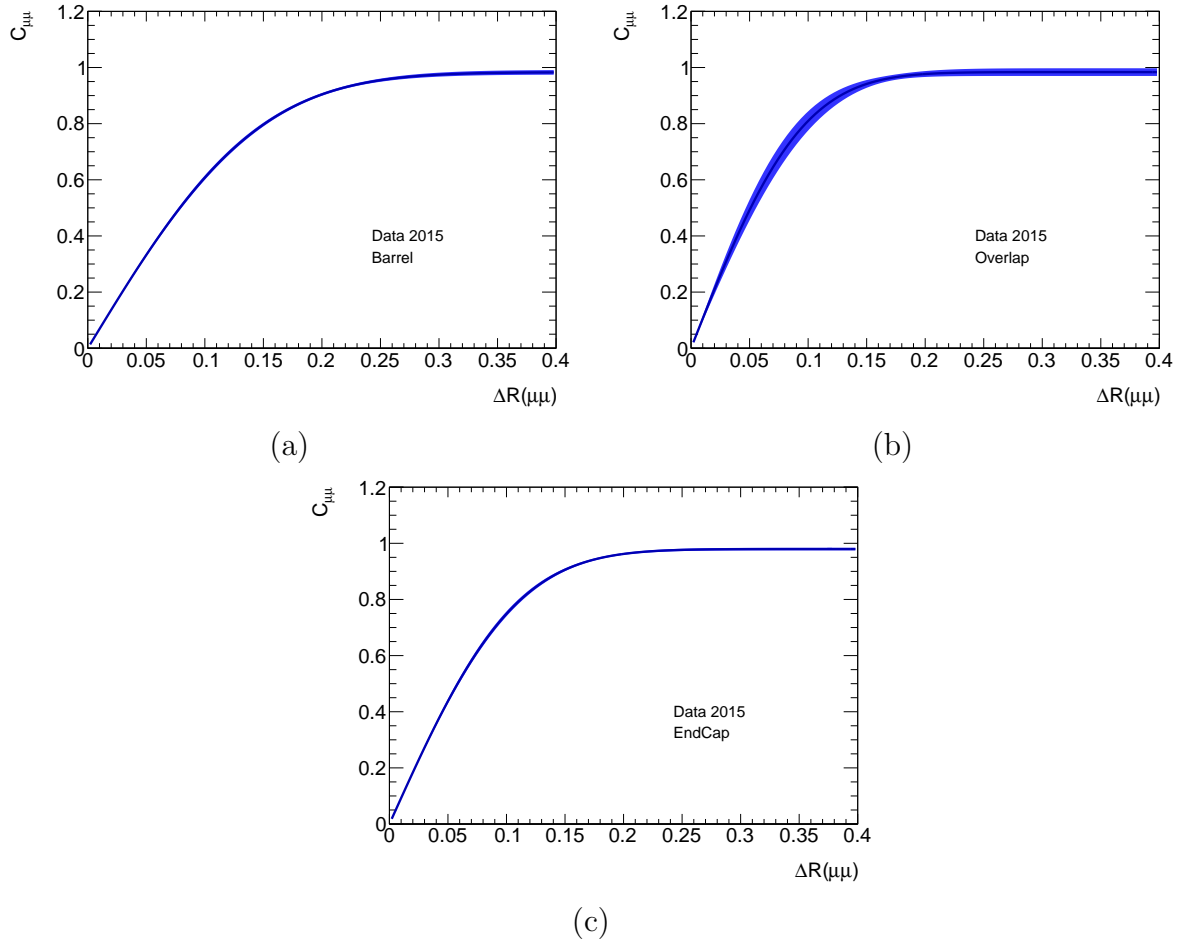

Figure 8: The total dimuon correction, $c_{\mu\mu}$, for HLT_2mu4_bJpsimumu trigger as a function of ΔR for data 2015 in (a) Barrel, (b) Overlap, and (c) EndCap regions. The uncertainty contour on the correction is $\pm 1\sigma$.

4 Summary

The study of the asymptotic dimuon correction, c_a , and the $c_{\Delta R}$ correction in data collected by the ATLAS detector in 2015 and MC samples is presented. Analysis of the asymptotic correction shows that the main part of efficiency loss comes from the vertex fit to dimuon invariant mass performed by fast L2 B-physics algorithm. The c_a values measured in MC are not consistent and require additional investigation. The product of the c_a and $c_{\Delta R}$ corrections gives the total dimuon correction of the trigger efficiency, $c_{\mu\mu}$, that is shown in Figure 8. Further steps of this analysis will be the measurement of the single muon efficiencies and check procedure mentioned above on MC using closure tests.

References

- [1] ATLAS Collaboration, *The ATLAS Experiment at the CERN Large Hadron Collider*, JINST **3** (2008) S08003.
- [2] ATLAS Collaboration, *Performance of the ATLAS Trigger System in 2015*, Eur. Phys. J. **C77** no. 5, (2017) 317, arXiv:1611.09661 [hep-ex].
- [3] ATLAS Collaboration, *Measurement of Upsilon production in 7 TeV pp collisions at ATLAS*, Phys. Rev. **D87** no. 5, (2013) 052004, arXiv:1211.7255 [hep-ex].